



Friction Stir Welding European Qualifications

Operator



Co-funded by the
Erasmus+ Programme
of the European Union

1. Bazele FSW

1.1 – Introducere in FSW

1.1 – Introducere in FSW

Sudare prin frecare cu element activ rotitor (FSW)

- Este un procedeu de imbinare a materialelor in care doua sau mai multe piese de metal sunt imbinate cu ajutorul caldurii rezultate in urma frecarii si amestecului de material aflat in stare plastifiata date de o unealta rotativa care nu se consuma si care se deplaseaza de-a-lungul sudurii

Prelucrare prin frecare(FSP)

- Este o varianta a procedului FSW . Procedul FSW modifică local microstructura și proprietățile zonei de sudură. Prelucrarea prin amestecare prin frecare aplică procedul FSW pe toata piesa. Unealta este introdusa și actionata înainte și înapoi modificând proprietățile materialului.

1.1 – Introducere in FSW

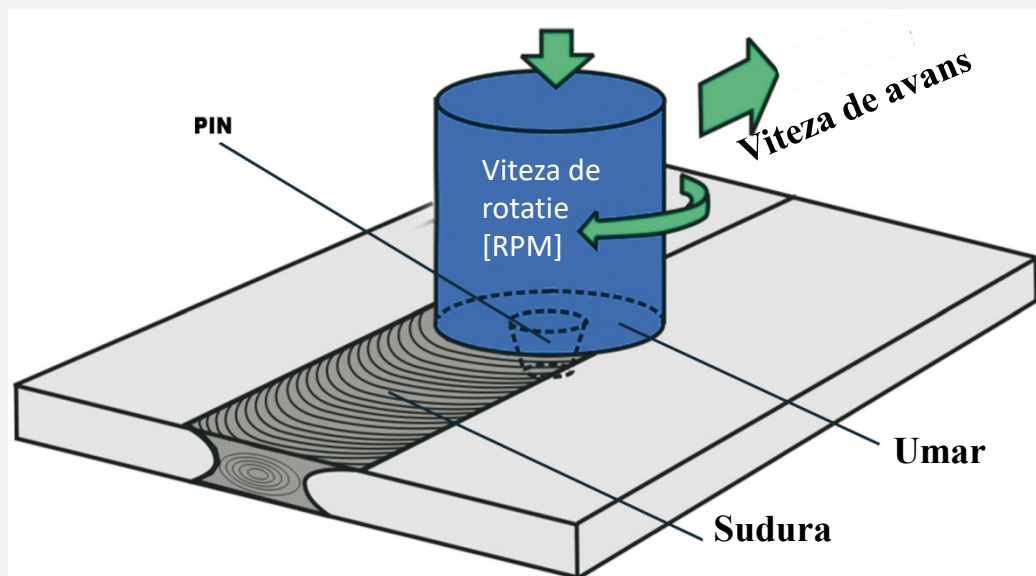

Friction Stir Welding (FSW)

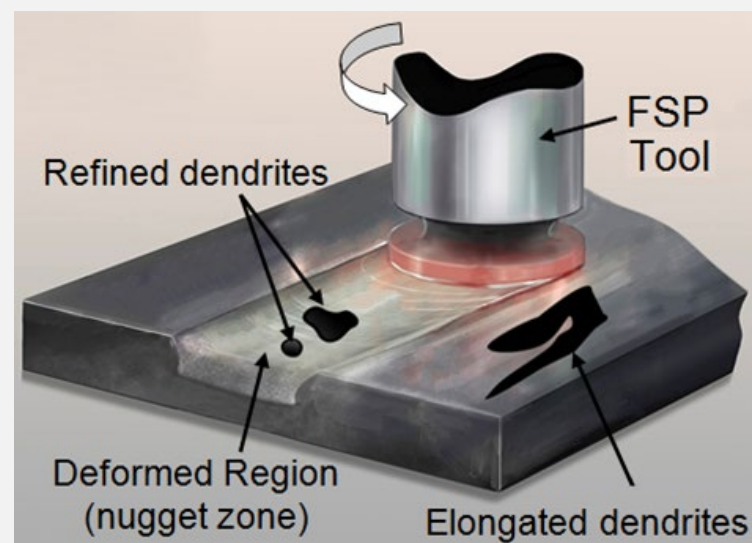

Friction Stir Processing (FSP)

1.1 – Introducere in FSW

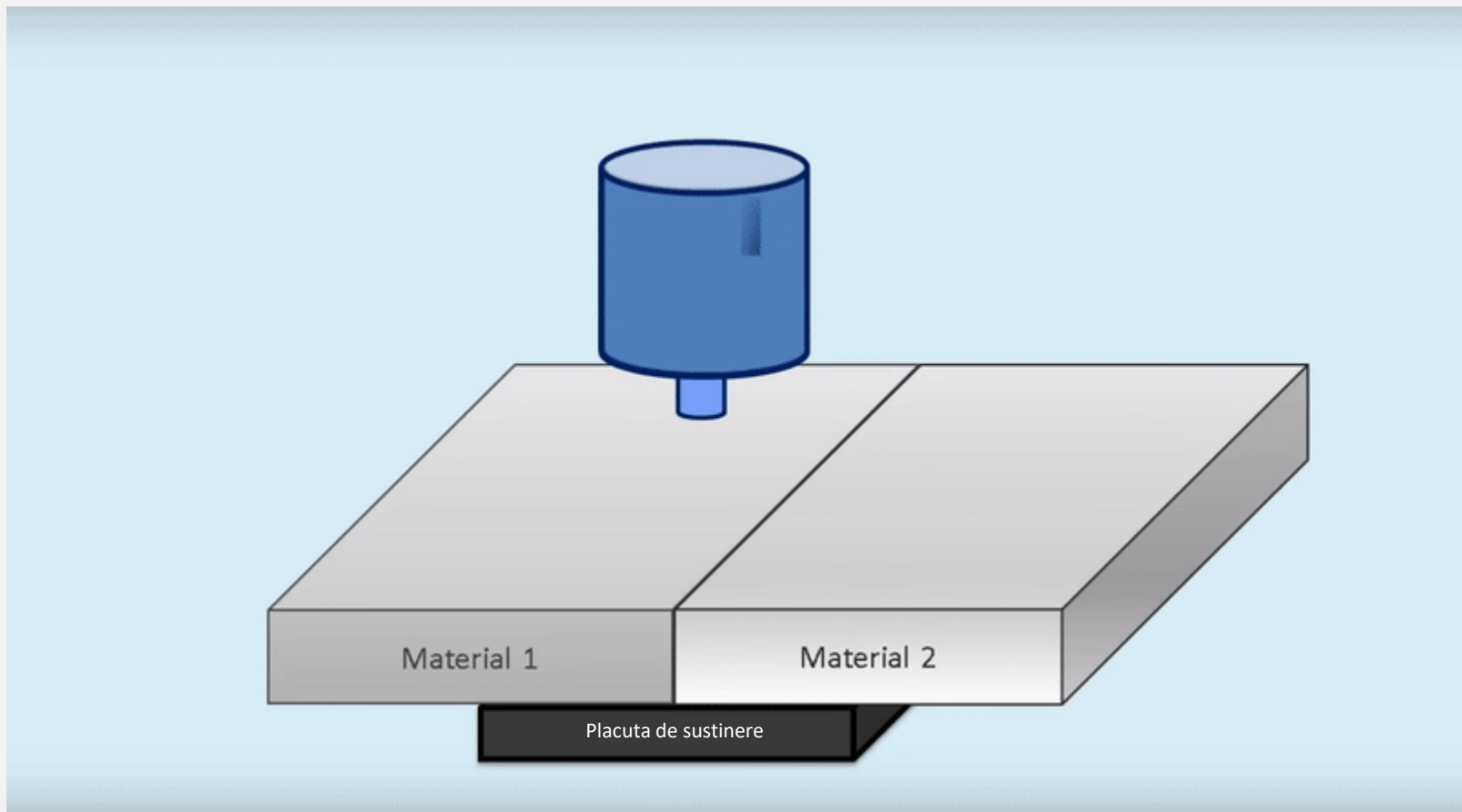

1.1 – Introducere in FSW

Avantaje din punct de vedere metalurgic:

- Procedeu de imbinare in stare solida
- Deformatii reduse
- Stabilitate dimensionala si reproductibilitate ridicate
- Nu se reduc elementele de aliere din materiale
- Proprietatie mecanice excelente in cusatura sudata
- Structura cu granulatie fina
- Neaparitia fisurarii la solidificare

1.1 – Introducere in FSW

Avantaje din punct de vedere al protectiei mediului:

- Nu este necesar gazul de protectie
- Necesita pregatire minima a suprafetei
- Nu exista deseuri rezultate de la operatia de polizare
- Nu exista solventi si degresanti
- Consum redus de materiale consumabile
- Absenta emisilor daunatoare

1.1 – Introducere in FSW

Avantaje din punct de vedere energetic:

- Consum mai redus de energie decat sudarea laser
- Consum redus de combustibil in aplicatii automotive, navale si aeronautice datorita greutatii reduse a pieselor imbinate
- Reducerea greutatii rezulta din folosirea materialor imbunatatite

1.1 – Introducere in FSW

Dezavantajele FSW ului:

- O mare parte din uzura uneltei are loc in etapa de plonjare
- Viteza de sudare in cazul sudurilor dintr-o singura trecere este mai mica la unele aliaje decat in cazul altor procedee de sudare prin topire cu arc electric
- Echipamentul folosit la FSW este masiv si scumpe din cauza fortelor foarte mari de apasare
- Materialele cu temperatura ridicata de topire, cum este otelul si otelul inoxidabil au unele limitari in ceea ce priveste unealta de sudare
- Absenta materialului de adaos duce la dificultati in realizarea sudurilor de colt
- Prezenta unui crater dupa sudarea FSW

1.1 – Introducere in FSW

FSW poate fi folosit in urmatoarele domenii industriale:

- Constructii navale si Off-shore
- Automotive
- Feroviar
- Aerospacial
- Fabricatie
- Altele (electric, petrol si gaze, industria nucleara, constructii)

1.1 – Introducere in FSW

In domeniul feroviar FSW este folosit in principal la sudarea panourilor de aluminiu pentru materialul rulant.

1.1 – Introducere in FSW



Domeniul feroviar – sudarea panourilor extrudate
complet automatizata

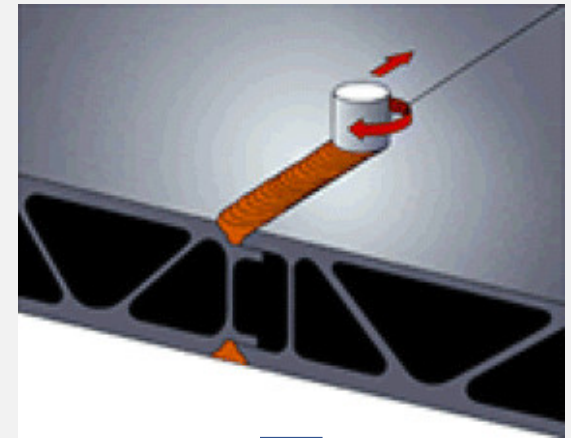

Sudarea panourilor extrudate

1.1 – Introducere in FSW

In domeniul automotive FSW poate fi utilizat la:

- Sisteme de inchidere
- rezervoare
- suspensii
- pistoane
- jante
- remorci

1.1 – Introducere in FSW



Automotive – fabricarea jantelor.



Sudarea FSW robotizata a unui element de caroserie auto

1.1 – Introducere in FSW

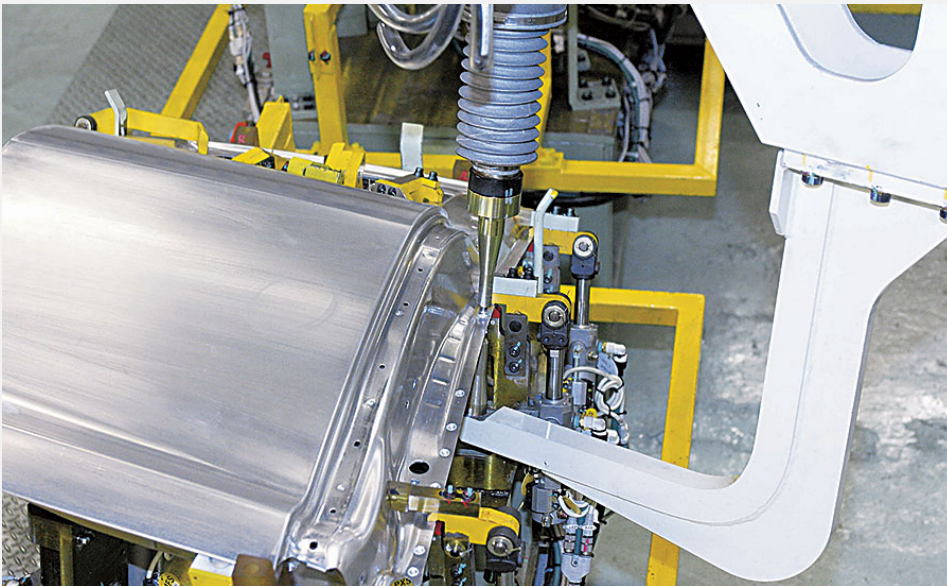

Sudarea FSW in puncte



Imbinarea materialelor diferite

1.1 – Introducere in FSW

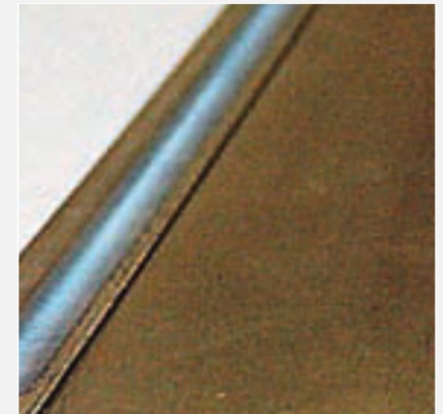

Aplicatii FSW in domeniul automotive: imbinarea pieselor de grosimi diferite, sudura de sigiliu si sudarea prin suprapunere.

1.1 – Introducere in FSW

In domeniul constructiilor navale, FSW se poate utiliza la:

- panouri de aluminiu pentru congelarea pestilor pe pescadoare
- Imbinarea elementelor extrudate pentru punti
- Panouri tip fagure
- Panouri rezistente la apa sarata

1.1 – Introducere in FSW



Constructii navale – panou de dimensiuni mari sudat FSW

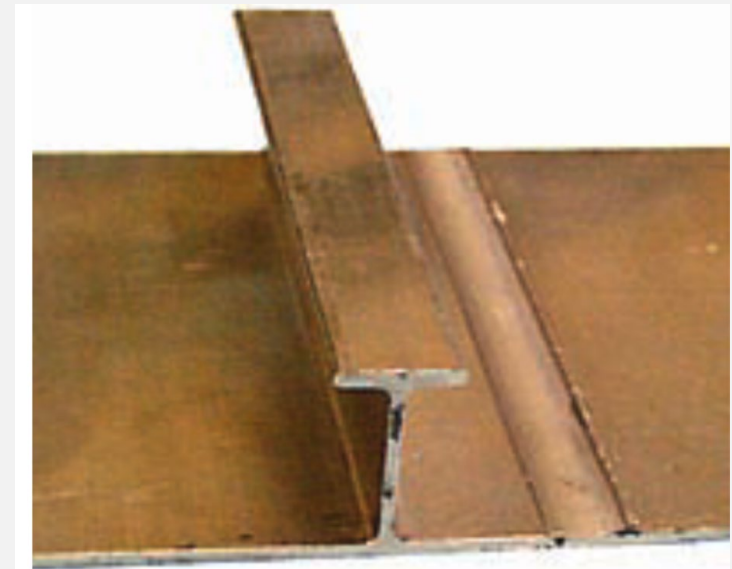

Panou sudat FSW

1.1 – Introducere in FSW

In domeniul constructiilor si al arhitecturii, FSW se poate utiliza la:

- podele
- tabliere
- pasarele
- pasaje
- pereti
- marchize
- Scuturi pentru intemperii
- Sisteme suspendate
- console

1.1 – Introducere in FSW



Constructii – bolta realizata cu FSW



Pasarela si scut pentru intemperii

1.1 – Introducere in FSW

In domeniul aerospacial, FSW se poate utiliza la:

- Rezervoare de combustibil pentru nave spatiale
- Panouri de aluminiu
- Ansamle tip sandwich
- Usile de la trenul de aterizare
- Fuzelaje avioane
- Aripi

1.1 – Introducere in FSW



Industria aerospaziala- panouri avion

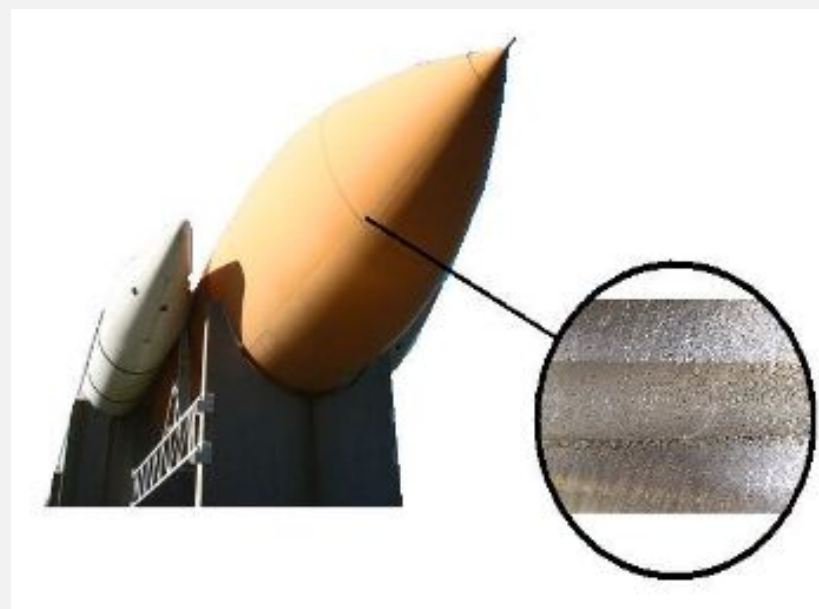

Rezervor combustibil racheta

1.1 – Introducere in FSW

FSW poate fi utilizat de asemenea si la:

- Carcasele motoarelor si a difuzoarelor
- chiuvete
- Unitate de incalzire, ventilare si racire a aerului
- Vase de vid
- Tavi pentru uscare – industria alimentara
- Canistre de cupru pentru deseuri nucleare



Friction Stir Welding European Qualifications



Co-funded by the
Erasmus+ Programme
of the European Union

1.1 – Introducere in FSW

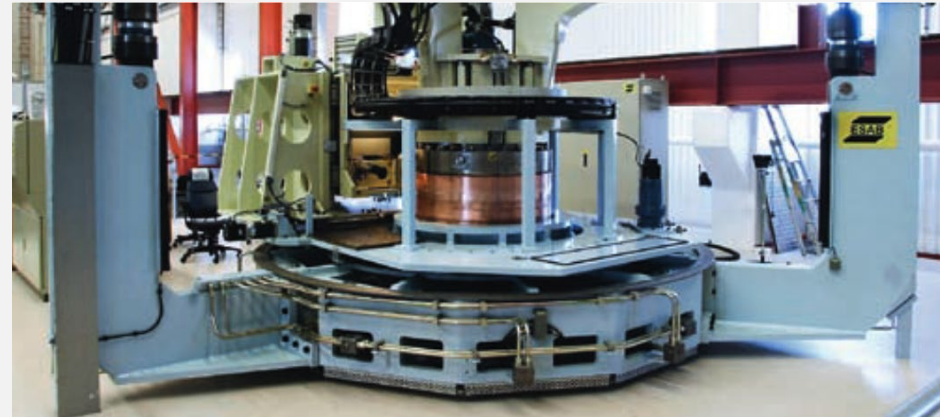

Industria nucleara – Canistra de cupru cu insertie metalica pentru combustibil nucleari sudata FSW

1.1 – Introducere in FSW

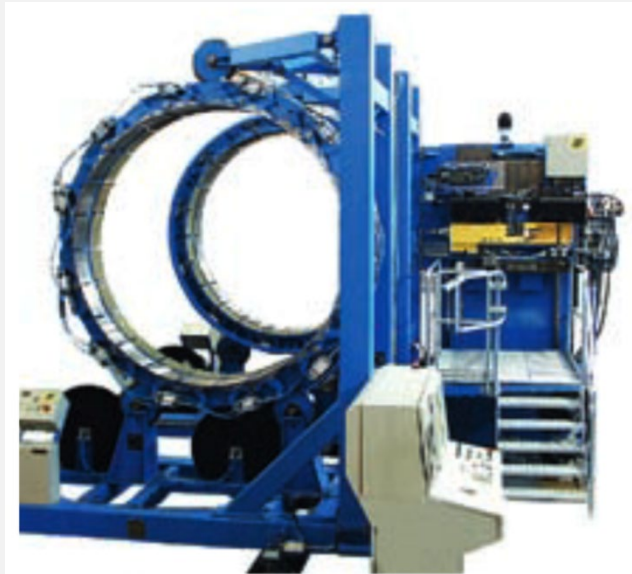

Echipament de sudare pe
circumferinta

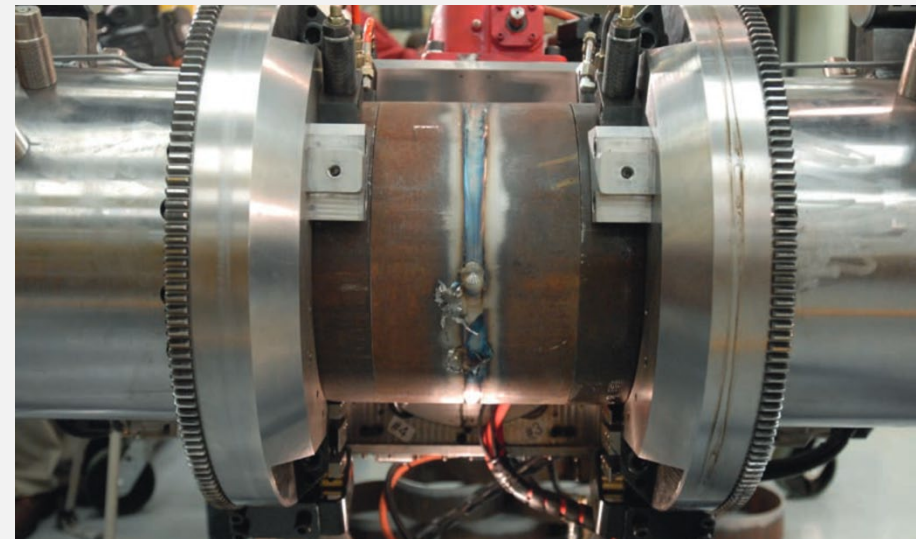

Sudarea FSW orbitala a unei tevi de otel



Friction Stir Welding European Qualifications



Co-funded by the
Erasmus+ Programme
of the European Union

1.1 – Introducere in FSW

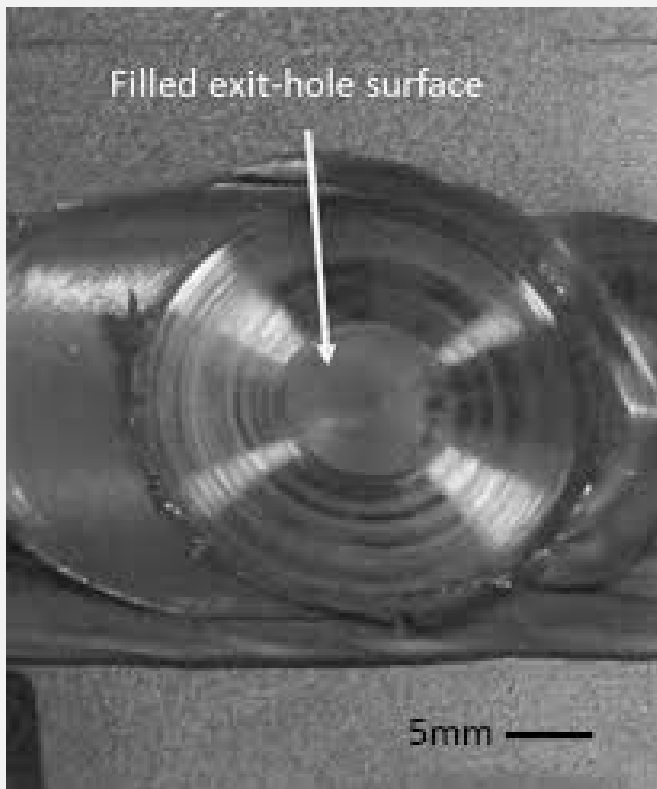

Crater de final incarcat



Cratere de final FSW tandem



Friction Stir Welding European Qualifications



Co-funded by the
Erasmus+ Programme
of the European Union



Friction Stir Welding European Qualifications



Co-funded by the
Erasmus+ Programme
of the European Union



Friction Stir Welding European Qualifications



Co-funded by the
Erasmus+ Programme
of the European Union



Friction Stir Welding European Qualifications



Co-funded by the
Erasmus+ Programme
of the European Union



Friction Stir Welding European Qualifications



Co-funded by the
Erasmus+ Programme
of the European Union

1. Bazele FSW

1.2 – Echipamentul de sudare

1.2 – Echipamentul de sudare

Cel mai simplu echipament de sudare FSW contine:

- ax
- motoare
- Mecanism de actionare a motorului
- unealta FSW

1.2 – Echipamentul de sudare

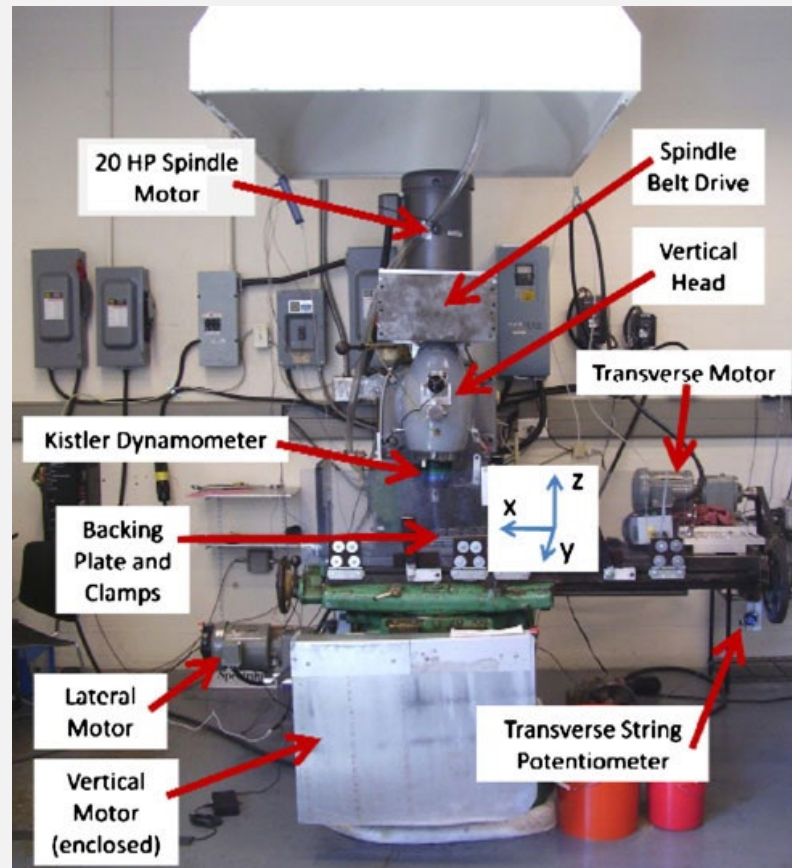

Example of FSW system configuration

1.2 – Echipamentul de sudare

Alte functii aditionale care pot fi incorporate in echipamentul de sudare, includ:

- Control CNC
- Monitorizarea productiei
- Monitorizarea temperaturii la sudare
- Urmarirea imbinarii
- Gaz de protectie
- fixari
- Sistem de achizitii date
- Senzori de inaltime

1.2 – Echipamentul de sudare

Echipeamente conventionale

- Cost initial scazut
- Flexibilitatea poate fi imbunatatita prin adaugarea mai multor motoare (mai multe grade de libertate)
- Rigiditatea masinii– trebuie intarita
- Sunt necesare solutii de control a fortei pentru a preveni deteriorarea echipamentului, pentru a asigura siguranta oamenilor si pentru a obtine o calitate buna a sudurii

Masina de frezat adaptata pentru FSW



1.2 – Echipamentul de sudare

Echipeamente FSW robotizate

- Repetabilitate ridicata si flexibilitate
- Cost relativ scazut
- Traseu 3D de sudare
- Automatizarea procesului
- Acuratete scazuta care scade si mai mult atunci cand sunt supuse la sarcini mari
- Rigiditate relativ mica si sarcina capabila moderata

Roboti cu brat articulata



1.2 – Echipamentul de sudare

Echipamente FSW robotizate

- Sarcini mai mari
- Rigiditate mult mai mare decat robotul cu brat articulata
- **Traseu 3D de sudare**
- Automatizarea procesului
- Costul lor este mai mare si volumul este mai mic decat robotul cu brat articulata

Robot paralel-cinematic



1.2 – Echipamentul de sudare

Echipamente FSW dedicate

- Incarcare capabila mare, rigiditate, acuratete si disponibilitate
- Configuratii posibile diferite si ca urmare nivelurile de flexibilitate
- Echipamentele FSW dedicate sunt cele mai robuste si rigide din punctde vedere structural (se sudeaza materialele rezistente la temperatura ridicata)
- Destul de scumpe iar costul creste odata cu cresterea flexibilitatii

Echipamente FSW dedicate

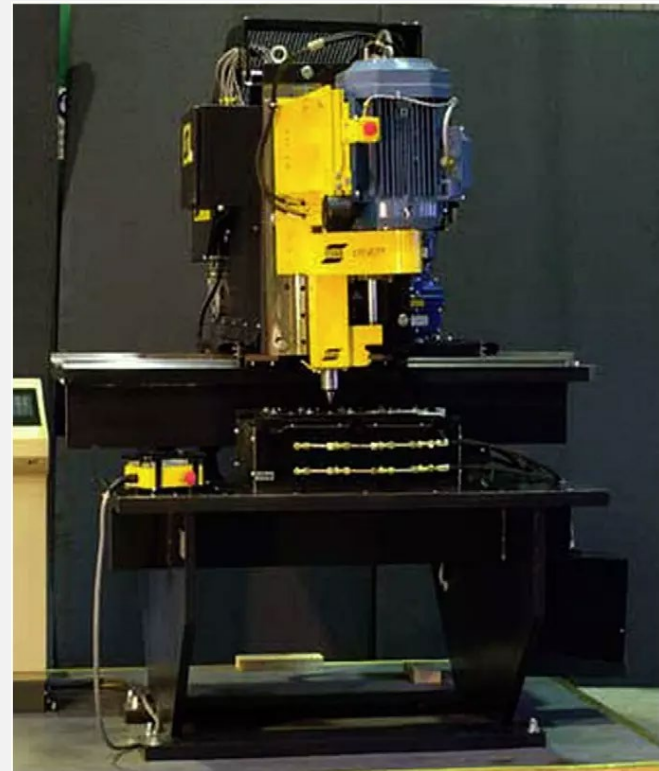

1.2 – Echipamentul de sudare

	Masina de frezat	Echipament FSW	Robot paralel	Robot articulata
Flexibilitate	Scazuta	Scazuta/medie	Ridicata	Ridicata
Cost	Mediu	Ridicat	Ridicat	Scazut
Rigiditate	Ridicata	Ridicata	Ridicata	Scazuta
Volum de lucru	Mediu	Mediu	Scazut	Ridicat
Timp de setare	Scazut	Ridicat	Mediu	Mediu
Numar de programe	Scazut	Mediu	Ridicat	Ridicat
Capabilitate de a produce suduri complexe	Scazuta	Medie	Ridicata	Ridicata
Tipul controlului	Deplasare	Deplasare/forta	Deplasare	Deplasare

1.2 – Echipamentul de sudare



Exemplu de unealta

1.2 – Echipamentul de sudare



Geometrii diferite de pin

1.2 – Echipamentul de sudare

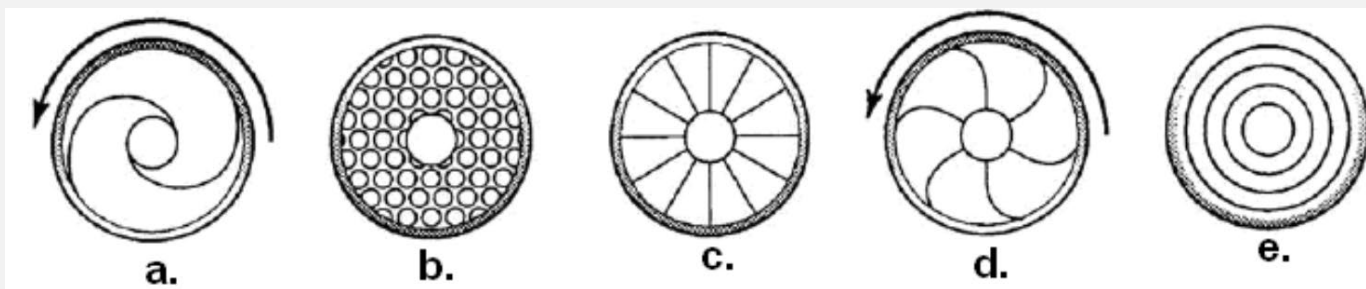

Caracteristici diferite ale umarului uneltei (sus) si exemplu de umar convex si scrolled (jos)

1.2 – Echipamentul de sudare

Sistemele posibile de prindere cuprind:

- Gheare de prindere
- Sisteme hidraulice si pneumatice
- Sisteme de prindere cu vid

1.2 – Echipamentul de sudare

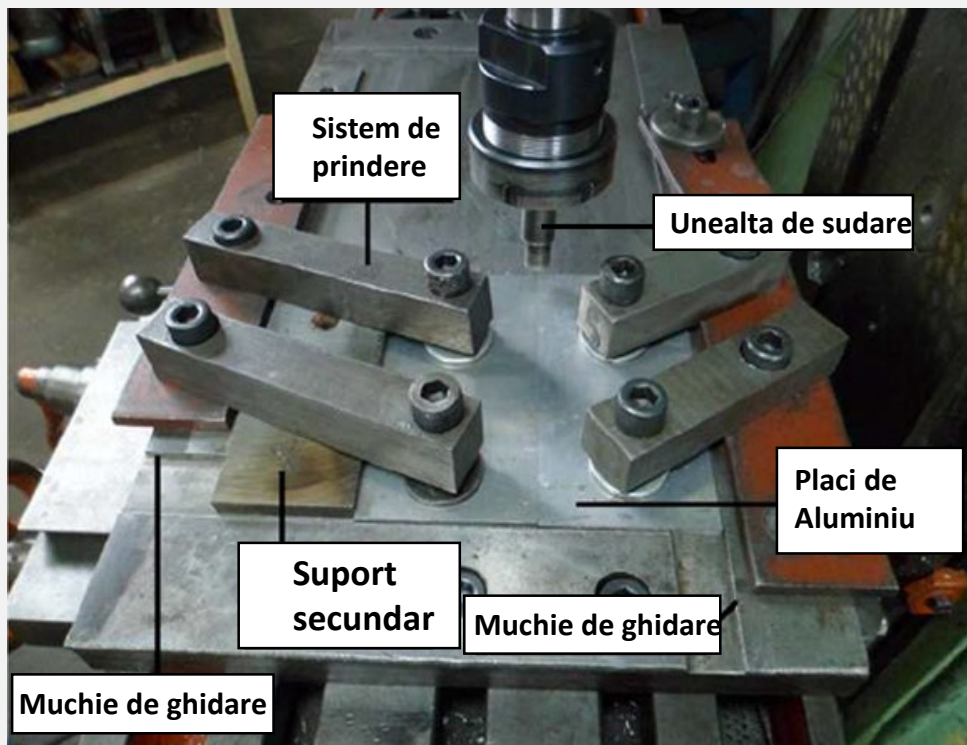

Sistem de prindere

1.2 – Echipamentul de sudare

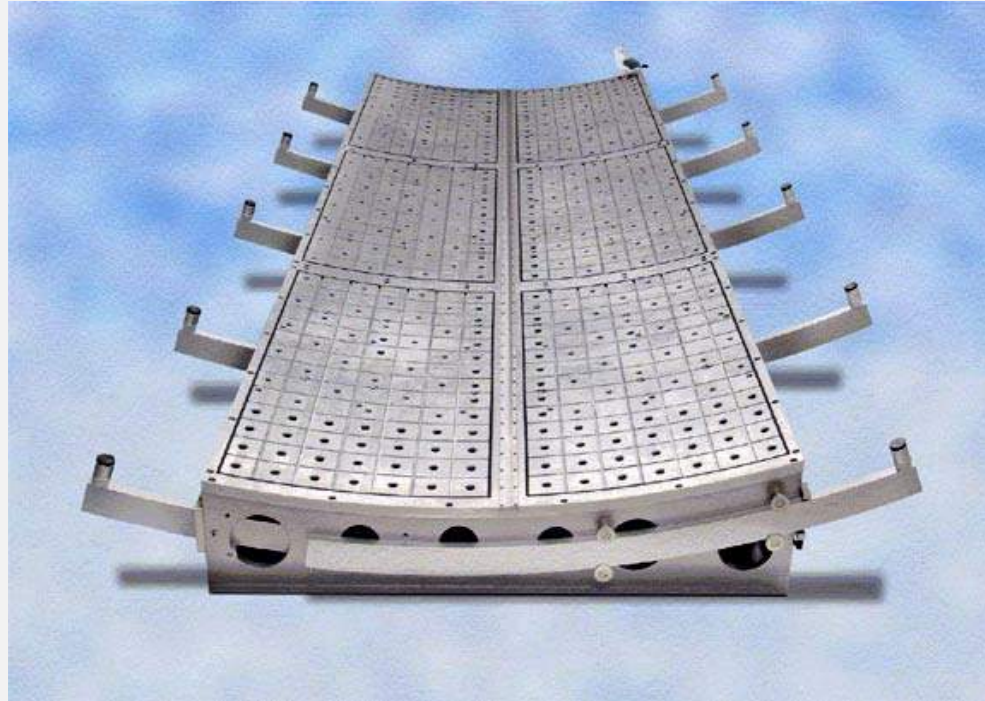

Sistem de prindere cu vid

1.2 – Echipamentul de sudare

Racire FSW cu

- Apa
- CO2 lichid
- Nitrogen lichid

- Otelul, titanul, otelul inoxidabil si aliajele rezistente la temperaturi inalte sunt sudate cu unelte racite cu lichid de racire

Incalzire

- FSW asistat electric
- FSW asistat laser
- FSW asistat cu arc
- FSW asistat cu energie ultrasonica

- Caldura poate minimiza uzura uneltei (in special din etapa de plonjare) si poate creste viteza de deplasare a uneltei

1.2 – Echipamentul de sudare

Componentele cheie ale echipamentului FSW cuprind:

- Cap de sudare cu motor
- Sine de ghidare cu componente
- Unitati hidraulice

Planurile de intretinere, inspectie si documentatia completa ar trebui sa asigure o functionare fara probleme pe termen lung

1. Bazele FSW

1.3 – Proceso de sudare

1.3 – Procese de sudare

Implicațiile în procesul de proiectare ale FSW :

- Limitari mecanice
- Limitari de fixare
- Limitari în ceea ce privește tipul îmbinării
- Limitari ale gaurilor de cheie
- Limitari ale uneltei și ale grosimii pieselor de sudat
- Material

1.3 – Welding processes

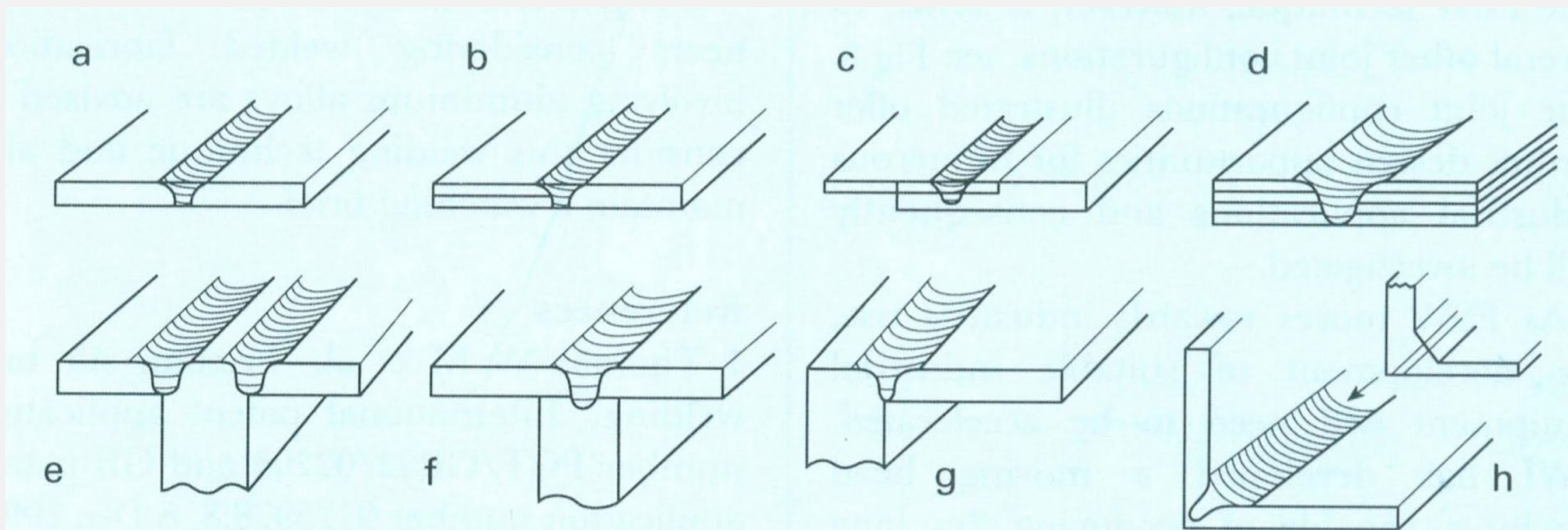

Tipuri de imbinari posibile: cap la cap; (b) si (c) prin suprapunere; (d) prin suprapunere cu mai multe placi; (e) cap la cap T (f) Prin suprapunere T (g) edge butt (h) de colt

1.3 – Procese de sudare

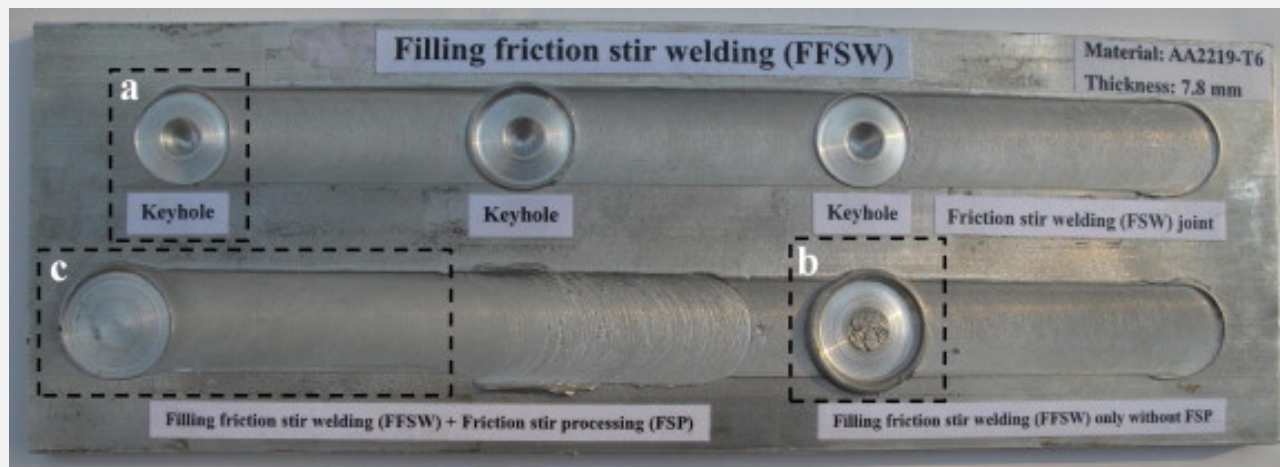
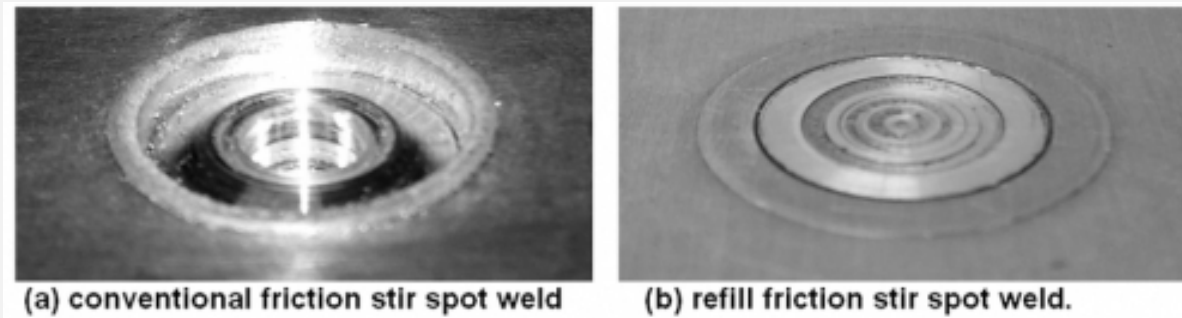

Umplerea gaurii de cheie

1.3 – Proceso de sudare

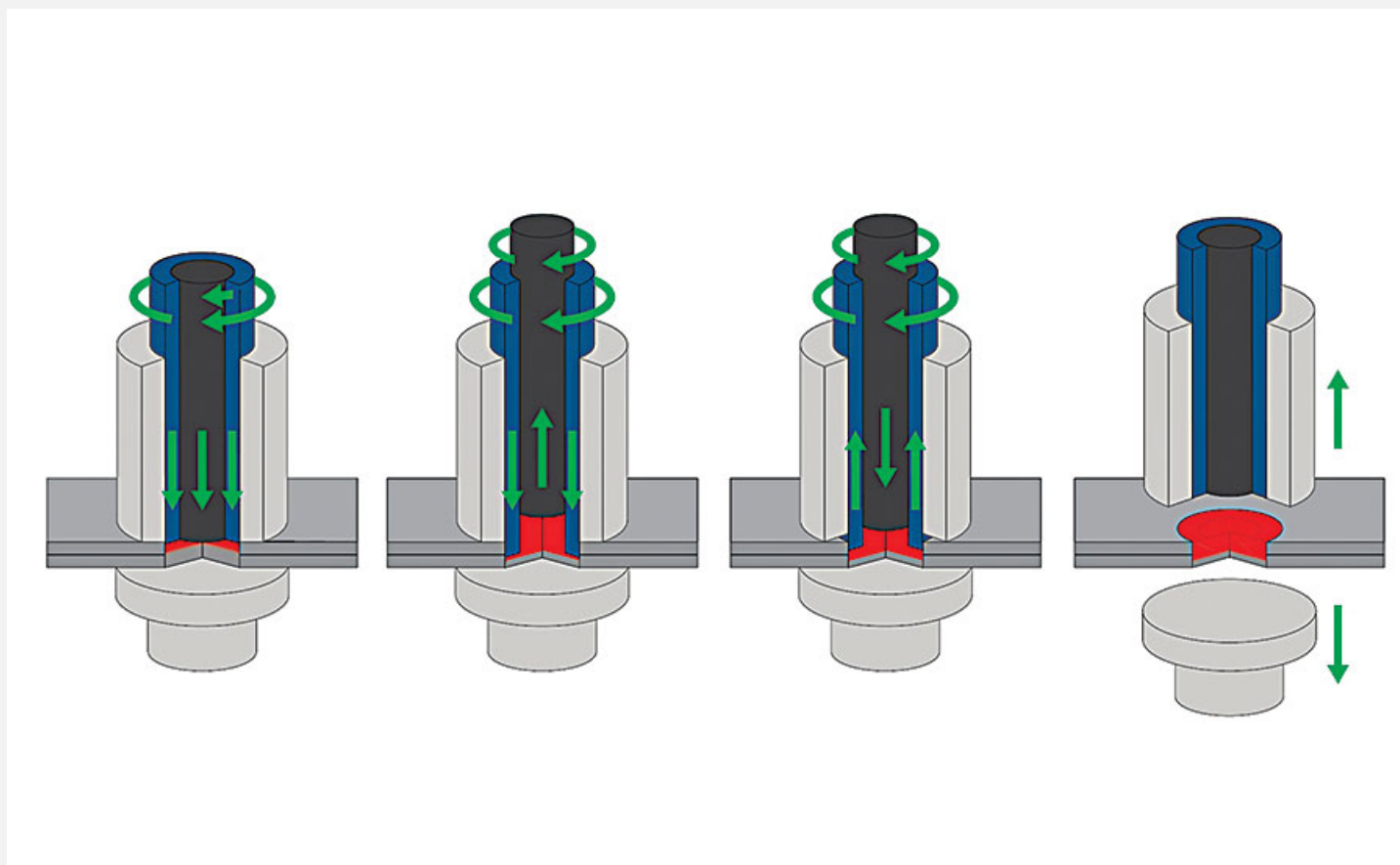

Procesul FSW de umplere

1.3 – Proceso de sudare

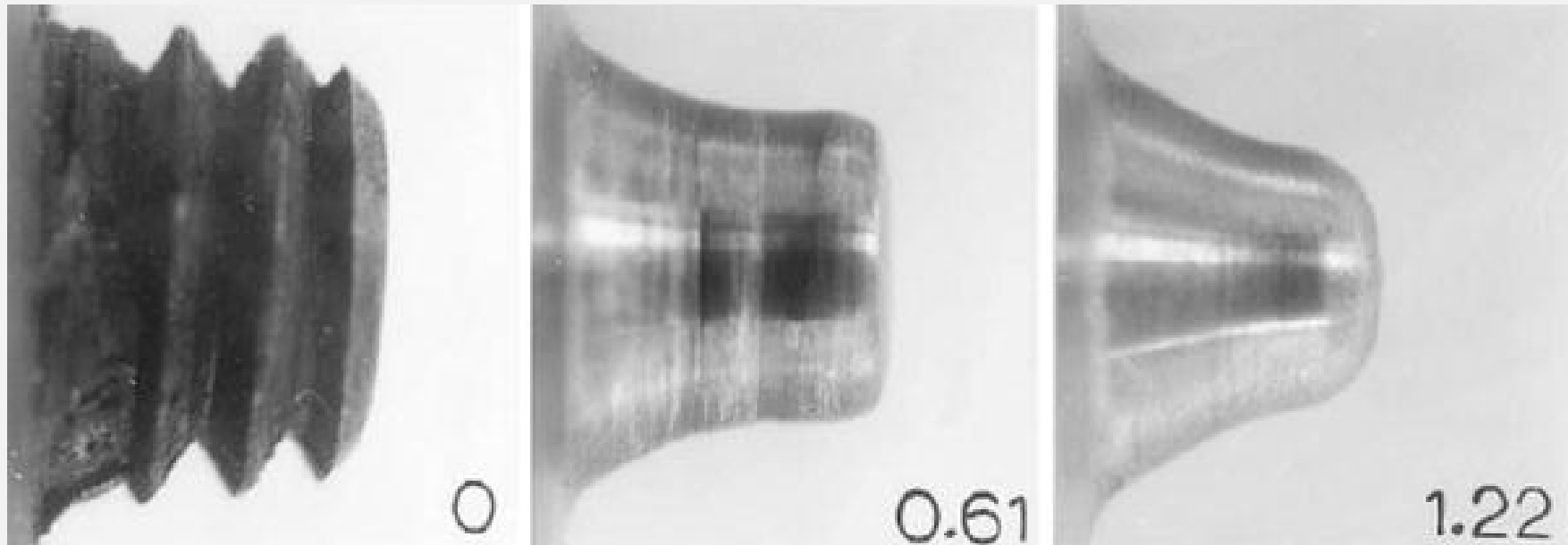

Uzarea uneltei

1. Bazele FSW

1.4 – Materiale de baza

1.4 – Materiale de baza

- FSW se poate utiliza la imbinarea materialelor ca aluminiu, cupru, magneziu, otel, termoplaste si titan.
- De asemenea este posibila imbinarea materialelor diferite
- Sudarea materialelor cu temperatura ridicata de topire este mai dificila, din cauza materialului uneltei de sudare care opereaza in conditii dure

1.4 – Materiale de baza

- Rigiditatea si manevrarea fortei sunt factori majori ai echipamentului FSW care limiteaza grosimea pieselor de sudat. Grosimea lor ar trebuie sa fie in intervalul 0.8mm - 65 mm.

Aliaj	Grosime, mm	Materialul uneltei
Aliaje de aluminiu	<12	Otel de scule, WC-Co
	<26	MP159
Aliaje de magneziu Cupru si aliaje de cupru	<6	Otel de scule, WC
	<50	Aliaje de Nichel, PCBN, aliaje de wolfram
	<11	Otel de scule
Aliaje de titan	<6	Aliaje de wolfram
Oteluri inoxidabile	<6	PCBN, aliaje de wolfram
Oteluri slab aliate	<10	WC, PCBN
Aliaje de nichel	<6	PCBN

Referinte

Slide:

[4] https://en.wikipedia.org/wiki/Friction_stir_processing

[4] http://www.uqac.ca/ceeuqac/index/csfm_english

[5] <https://www.youtube.com/watch?v=ZpGfjg6BI5o>

[12] <http://assets.esab.com/asset-bank/assetfile/12296.pdf>

[12] Cam, G., & Mistikoglu, S. (2014). Recent developments in friction stir welding of Al-alloys. *Journal of Materials Engineering and Performance*, 23(6), 1936-1953.

[14] https://spinoff.nasa.gov/Spinoff2008/ip_4.html

[14] <https://phys.org/news/2014-06-lighter-cars-robotic-welding-method.html>

[15] <https://www.assemblymag.com/articles/93337-friction-stir-spot-welding>

[15] <http://www.ftech.co.jp/en/development/>

[16] <http://assets.esab.com/asset-bank/assetfile/12296.pdf>

[18] <http://assets.esab.com/asset-bank/assetfile/12296.pdf>

[20] <http://assets.esab.com/asset-bank/assetfile/12296.pdf>

[20] <https://www.productionfrictionstirwelding.com/architecture-and-construction-products>

Referinte

Slide:

[22] <http://www.gatwicktechnologies.com/applications/body-panels>

[25] <http://assets.esab.com/asset-bank/assetfile/12296.pdf>

[26] <http://assets.esab.com/asset-bank/assetfile/12296.pdf>

[28] Behmand, S. A., Mirsalehi, S. E., Omidvar, H., & Safarkhanian, M. A. (2015). Filling exit holes of friction stir welding lap joints using consumable pin tools. *Science and Technology of Welding and Joining*, 20(4), 330-336.

[28] https://www.researchgate.net/figure/Tandem-twin-stirTM-lead-and-follow-exit-holes_fig4_228600743

[36] Longhurst, W. R., Strauss, A. M., Cook, G. E., & Fleming, P. A. (2010). Torque control of friction stir welding for manufacturing and automation. *The International Journal of Advanced Manufacturing Technology*, 51(9-12), 905-913.

[38] <http://www.bil-ibs.be/en/friction-stir-welding>

[39] https://www.asiamachinery.net/supplier/product_details.asp?ProID=13282&SupID=7312

[40] Mendes, N., Neto, P., Loureiro, A., & Moreira, A. P. (2016). Machines and control systems for friction stir welding: a review. *Materials & Design*, 90, 256-265.

[41] <http://www.directindustry.com/prod/esab/product-18224-981963.html>

[42] [40] Mendes, N., Neto, P., Loureiro, A., & Moreira, A. P. (2016). Machines and control systems for friction stir welding: a review. *Materials & Design*, 90, 256-265.

[43] Maria Asli Sicilan and S. Senthil Kumar "Analysis of Surface Quality of Friction Stir Welding Joints using Image Processing Techniques "International Conference on Emerging Trends in Engineering & Technology, Travancore Engineering College, Kollam, Kerela, India. 03/2014

Referinte

Slide:

[44] <http://www.phase-trans.msm.cam.ac.uk/2011/tools.html>

[45] Pasha, A., Reddy, R., Laxminarayana, P., & Khan, I. A. (2014). INFLUENCE OF PROCESS AND TOOL PARAMETERS ON FRICTION STIR WELDING—OVER VIEW. *Int J App Eng Technol*, 4(3), 54-69.

[47] Pastor, A., & Svoboda, H. G. (2013). Time-evolution of heat affected zone (HAZ) of friction stir welds of AA7075-T651.

[48] https://www.aerospace-technology.com/contractors/sub_contract/horst/attachment/horst3/

[54] Han, B., Huang, Y., Lv, S., Wan, L., Feng, J., & Fu, G. (2013). AA7075 bit for repairing AA2219 keyhole by filling friction stir welding. *Materials & Design*, 51, 25-33.

[54] <https://uwaterloo.ca/centre-advanced-materials-joining/laboratory-facilities-and-equipment/production-equipment/friction-stir-welding-equipment>

[55] <https://www.assemblymag.com/articles/93337-friction-stir-spot-welding>

[56] Wang, D., Xiao, B. L., Ni, D. R., & Ma, Z. Y. (2014). Friction stir welding of discontinuously reinforced aluminum matrix composites: a review. *Acta Metallurgica Sinica (English Letters)*, 27(5), 816-824.

[59] Rajiv S. Mishra, Murray W. Mahoney, *Friction Stir Welding and Processing*, ASM International, 2007